

MODELS A2, AA2, A2R AND AA2R

A creep action thermostat/thermal protector with highest contact rating of all Model A Series thermostats. Equipped with gold diffused contacts for use in low voltage/low current applications.

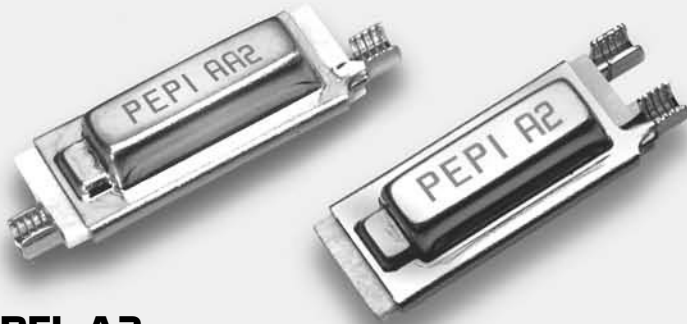

MODEL A2

TOP VIEW

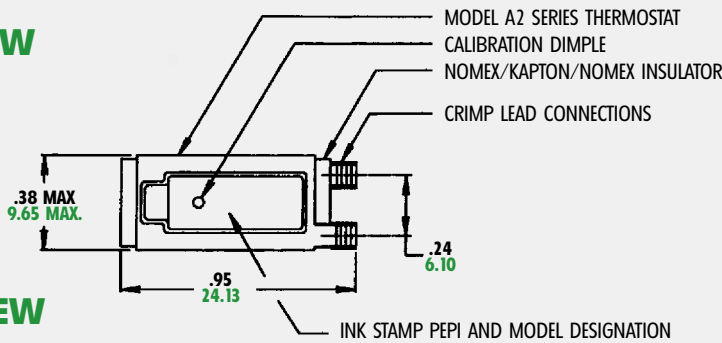

SIDE VIEW

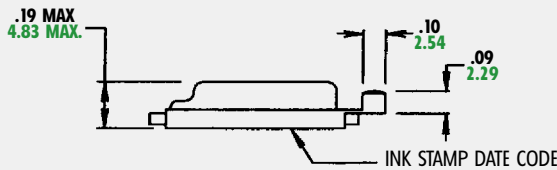

MODEL AA2

TOP VIEW

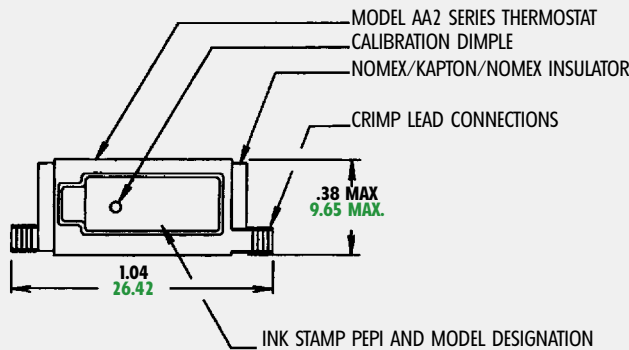

SIDE VIEW

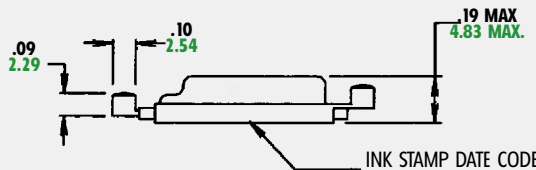

METRIC DIMENSIONS ARE IN MM (SHOWN IN GREEN)

Copyright 2006, Portage Electric Products, Incorporated, all right reserved

FEATURES

- Conductive bimetal construction; the bimetallic element carries the circuit current.
- Creep action device; slow make/slow break switching action.
- No built-in differential between the opening and closing temperature.
- Case electrically live; insulating sleeving is available.
- Preset calibration temperature; not adjustable in the field.
- Available to open circuit on rise of temperature (normally closed), Models A2 and AA2, or close circuit on rise of temperature (normally open), Models A2R and AA2R.
- Equipped with gold diffused, fine silver contacts for use in low voltage/low current applications.
- Available with same end termination, Models A2 and A2R; or opposite end termination, Model AA2 and AA2R.
- Available with factory applied lead wires.

CONTACT RATINGS

- 5 amps/120 volts AC resistive
- 4 amps/120 volts AC inductive
- 6 amps/12 volts DC restrictive

CALIBRATION TEMPERATURE RANGE

- Available with nominal calibration temperatures from 5°C to 200°C.

Please consult our Sales Engineers for suggested contact ratings when applied to DC type loads.

CURRENT DERATING CURVE

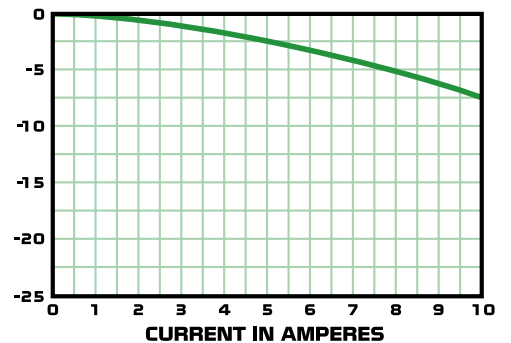

We come through when the heat is on™

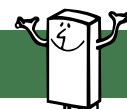

Pepi®

Portage Electric Products, Inc.